

## Metallurgy

## Iron and steel making in the third millennium

L.F. Verdeja, J.P. Sancho and J.I. Verdeja

**KEYWORDS:** Metallurgy, Iron, Steel, Information technologies, Biotechnology, Iron making, Steel making.

Paper reviewed and approved for publication by The Metallurgical Society of CIM.

## ABSTRACT

*This paper analyzes the present state of the different processes competing to keep their market shares within the future iron and steel business sector.*

*The continuous transformations in the steel making process are also studied here. These transformations have happened especially during the two last decades obviously favouring steel price, properties, quality and environmental compatibility in the new millennium.*

## Introduction

In the early 1980s, world steel production reached a historic figure; specifically in 1982, the amount was 645 Mt (Verdeja et al., 1993). This might have been one of the reasons why the United States, Japan and the European Community drew up a declaration of principles after which the leading industries and sectors in the following century's development would be: advanced materials, also known by the very dif-

fuse term of new materials; information technologies; and biotechnology (Eager, 1998).

On the threshold of the 21st century, it can be inferred that information technologies (computers and telecommunications) have progressed spectacularly. Nevertheless, there have been downsides too; technology develops so quickly that after a few months the products are obsolete. Environmental problems may also appear in a few years due to storing so many useless devices. At the same time, the achievements of biotechnology did not meet the optimistic forecasts made in the early 1980s.

On the other hand, it is also curious that some solutions for the environmental problems generated by star technologies of the new millennium, such as computers and biotechnology, are closely linked to the iron and steel industry. For example, blast furnaces in Germany and Japan are prepared for burning residua by introducing polymer materials from computers and other electronic prepared devices through their tuyeres, while cement tube furnaces can destroy any organic residua from different origins.

The characteristics of industrial sectors concerned with the development of future materials are the availability of good raw materials, low cost and attractive properties in comparison with other competitive materials and a high recycling rate. In the case of steel and paper, the recyclability is 44%, followed by glass with 35% and aluminium with 33%. Plastic and other polymer materials only have 6% recyclability.

Advanced materials have clearly had a leading role in technological changes in the past decades. Nevertheless, it is still necessary to consider the following:

- New materials should not be interpreted as just including materials such as YBACUO ( $\text{YBa}_2\text{Cu}_3\text{O}_7$ ) and high temperature superconductors (90 K), but also others like the 0.12 mm tinplate used in the food industry for making cans.
- Most traditional materials, e.g., metals, ceramics and structural polymers, (Table 1; Fig. 1) have experienced a quiet revolution gradually achieving spectacular price reductions and remarkable properties and quality improvements during the last three decades. Socially, most of the progress in materials science and technology has been dimmed by the dramatic changes that some functional properties have undergone, such as those developed in computer software and hardware.

Steel is one of the leading materials in this quiet revolution, taking into account the

Table 1. The world materials production

Material	Production ( $10^6$ t)
Cement	1500
Steel	829
Polymers	190
Paper	140
Cast irons	105
Wood	75
Aluminum	30
Glass	24

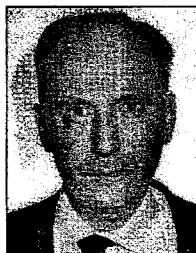

**Luis Felipe Verdeja** obtained a Ph.D. in chemistry from Oviedo University. He is a professor of iron and steel at the High Mining School in Oviedo, Asturias. Dr. Verdeja has authored 75 papers on materials and metallurgy and is a member of TMS, ACS and IOM.

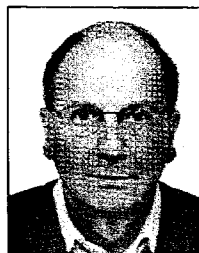

**Jose Pedro Sancho** obtained B.Sc. degrees in mining engineering from Oviedo University (1970) and in metallurgical engineering from Leeds University, United Kingdom (1971), and a Ph.D. degree in 1974. Dr. Sancho has authored 80 papers on extractive metallurgy and properties of metallic and ceramic materials. He has been a professor of metallurgy since 1975 and a chairman since 1981.



**Jose Ignacio Verdeja** graduated from the School of Mines (Madrid, Spain) in 1968. He author 105 papers on metals solidification and processes, metallography, mechanical properties and textures. He has been a professor of materials science since 1983.

remarkable improvements in its properties and use. Nevertheless, another important part of this revolution, with striking social repercussions in this case, has been the drastic price reduction due to implementing new management methods and new production and transformation technologies. Unfortunately, society has received an image of "absolute crisis" in the steel industry after a dramatic employment cut-back and with considerable extensions of land occupied by facilities which are now useless.

Despite all this, in the authors' opinion, the danger has been in identifying these visible negative aspects of the steel industry rationalization with the belief that its products lack a future and that the "technological revolution" at the end of the century would not take them into account.

Although at present, the important role of steel in the material technology development is not in doubt, in the early 1980s, analyses and predictions were quite different (Fig. 2). During the last decades in the century, some writers have been working against the mainstream in the belief that steel and other materials also considered traditional are incompatible with an advanced technological development (Verdeja et al., 1998).

A paper in the magazine *Revista de Minas*, published by the Oviedo School of Mining Engineering in 1993, predicted that "despite the crisis in the sector, the rationalization that is taking place in the European Union, Japan and the United States, not only relating

to installed capacity but also to improving productivity, will allow industries to witness a new splendid era in their financial balance at the end of the century and the beginning of the new millennium" (Verdeja et al., 1998). Perhaps disillusion after the alarmist forecasts has led some people to think that the best that the steel industry can do is to stop speculating about what its future could be and try to "invent" it (Fruehan, 1996; Edington, 1997; Wiesinger, 1999; Verdeja et al., 2000; Sancho et al., 2000).

It is certainly necessary to gain and shape the future in any of our activities, but it is also true that all the future developments have their origins in the past. Predictions based on a deep and rational analysis of the situation of this sector have to be assessed as undoubtedly important material. For example, the sector's growth or recession expectations may be weighed up using steel production statistics in various regions (Table 2):

- Development possibilities in North America (Canada, the United States, Mexico) and Western Europe, which are regions with a high per capita consumption (350 kg), will be particularly involved in incorporating new production technologies and setting up new production units, preferably placed in Mexico.
- In Eastern European countries, after their historic record in 1989, there has been an extremely recessive period due to the drastic downfall in the military industry and to non-

competing processes; in 1991, they still produced as much as 76 Mt of Siemens steel.

- The spectacular expectations about Asian growth originate from the low per capita consumption that some countries in the area have which is still far from reaching the world average of 150 kg. However, Japan and Korea, with a per capita consumption somewhat higher than the European Union average of 350 kg, are mainly exporters. These circumstances lead to disorders in raw material and steel derived product markets when the economy in the countries or affected regions goes into recession.
- Production growth in South and Central America and Africa Oceania, although spectacular, is just 5.9% and 4.9% of the world total, respectively; the estimated world production in 2010 is 981 Mt (Wiesinger, 1999).

In order to more accurately analyze the present state of steel production and transformation, the steel process has been divided into four large sections which, from primary metallurgy to so-called quaternary metallurgy, study the most promising aspects of the processes as well as both mature and developing technologies in the third millennium.

**Primary Metallurgy**

Steel primary metallurgy embraces all processes and technologies aimed at obtaining the following products:

- Pig iron and other similar casts: BF, Corex, Tecored, AISI, CCF, Dios, Finex, Hismelt y Romelt.
- Direct reduction iron (DRI) and hot briquetted iron (HBI) sponge: Midrex, HYL, Arex, Circored, Finmet, Ghaem, Spirex, Circofer, Comet, Corex-Or, Astuet and Inmetco (Fig. 3).

**Table 2. Steel production by areas in 1989-2010 period**

Region	Total Production (10 <sup>6</sup> t)			
	1989	1999	2000	2010
Africa and Oceania	22	23	25	48
Asia	290	340	361	424
South and Central America	29	39	44	58
North America	95	120	127	145
Eastern Europe	189	108	116	136
Western Europe	161	150	156	170
World Total	786	780	829	981

**Fig. 1. Steel per capita consumption (kg) as a function of GNP (\$ per capita).**

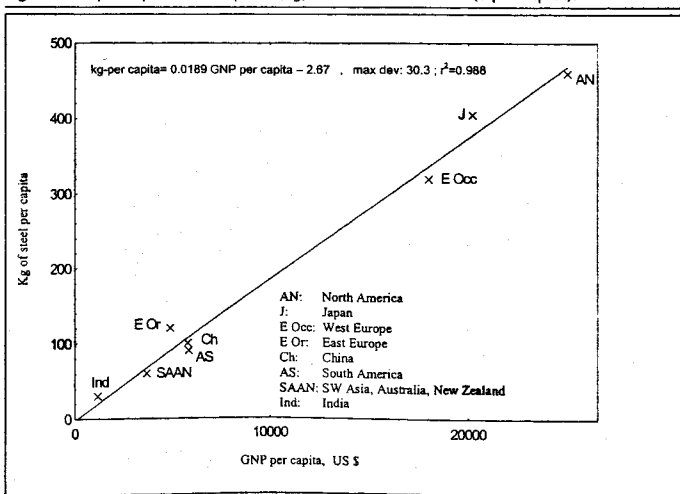

**Fig. 2. The evolution of engineering materials.**

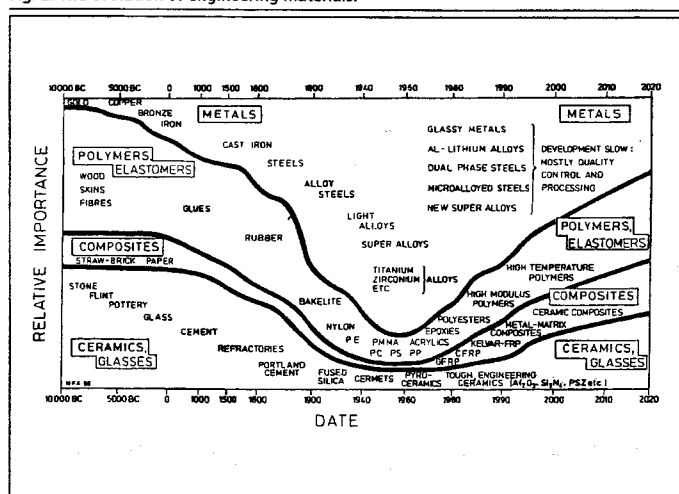

Fig. 3. Comet process.

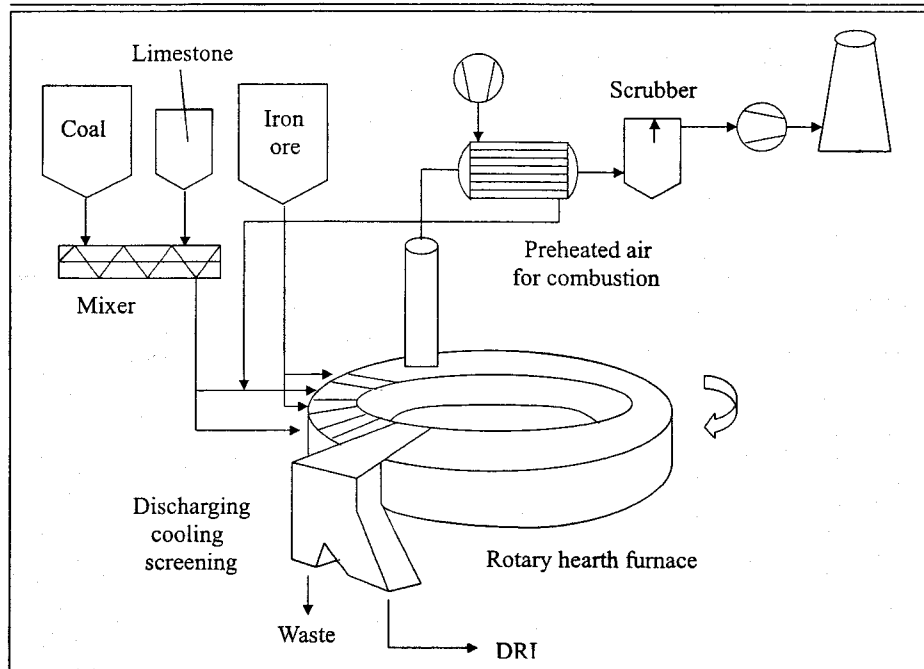

Fig. 4. Iron carbide process.

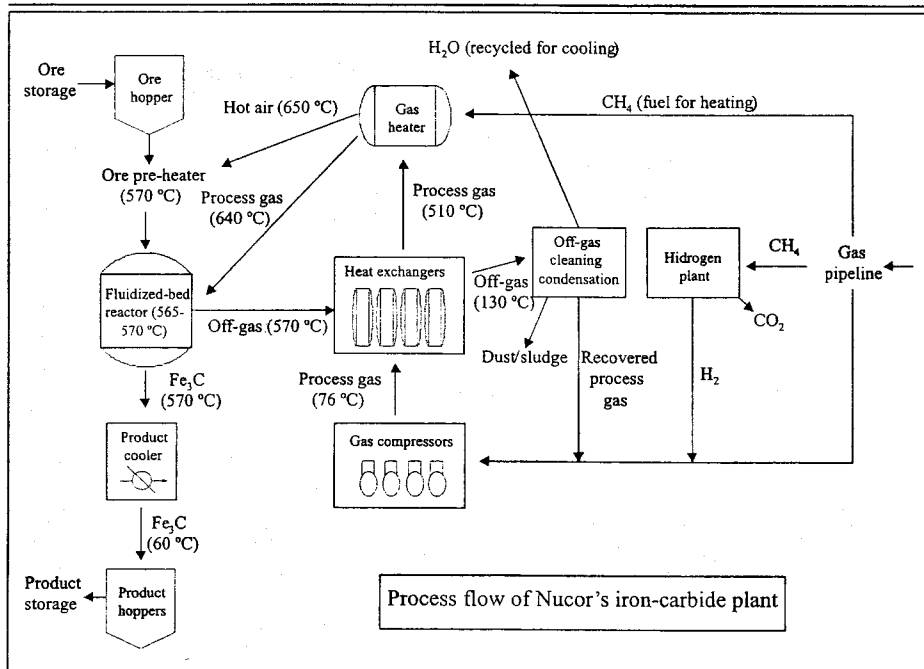

Table 3. Alternatives for iron ore reduction

Product	Reducing Smelting		Direct Reduction (DRI)		
	Pig Iron		Iron Sponge DRI/HBI		Fe <sub>3</sub> C
	Reducing Agents				
Ferric Load	Coke + Other	Coal/O <sub>2</sub>	Natural Gas	Coal	Natural Gas
Gross	Blast Furnace	Corex	Midrex	SU/RN	
Pelets	Blast Furnace	Corex	HYL-III	DRC and Fastmet	
Sinter	Blast Furnace	AISI	Arex		
Green pellets				Inmetco	
Fines		Finex CCF Dios Hismelt Ausmelt Romelt	Fior Finmet Cincored Spirex	Circofer Comet	Iron Carbide

- Iron carbide (cementite, Fe<sub>3</sub>C; Fig. 4).
- Non-calibrated liquid steel: BOF and EAF.

Table 3 shows the possible alternatives for obtaining pig iron, iron sponge and cementite, whereas, Figures 5 and 6 represent two of the most usual processes for obtaining non-adjusted liquid iron (BOF + EAF) and the interactions among these and other processes in primary steel metallurgy.

Basically, the final objective of primary steel metallurgy is producing non-adjusted liquid. Technologies have been proposed as simplifying techniques for reducing the mineral and producing refined liquid iron in a single operation. These techniques are similar to those proposed by the American Iron and Steel Institute (AISI) (Fig. 7; Agarwal, 1991), although none of them has been tried in a pilot industrial plant yet.

The steel industry will keep using the blast furnace as one of the key technologies for obtaining non-calibrated liquid steel; 65% of the world steel production comes from cast iron produced in blast furnaces. The main problems with the technology for producing pig iron in a blast furnace have been the following: high coke consumption; high installation costs; and environmental problems, mostly due to auxiliary installations (coking, sintering and pelletizing plants).

Nevertheless:

- Reducing coke consumption in a blast furnace has been constant since the 1970s, due not only to technological improvements in the facilities but also to the more frequent use of pulverized coal injections through tuyeres.
- The capital needed to obtain one ton of finished product has been one of the main disadvantages against having private investments in the integral steel industry (process sequence: blast furnace → converter → conventional laminating). Around the middle of the last century, national capital normally provided initiatives for building steel industry plants. Private capital underwent too much of a risk in those inflationist economies. But the change in the last decade of the century has been spectacular. Although there are still some companies with national participation left, private capital has come back to the sector favoured by the drastic decrease of installation costs and a low inflation rate. For example, an integral plant with a 6 Mt/year productive capacity cost 4000•10<sup>6</sup> current dollars in 1965, whereas, it would be about 1860•10<sup>6</sup> dollars today.

Conventional furnace coke production technology (traditional coking plant) reached its highest possibilities during this decade while achieving satisfactory environmental parameters too, (Ameling et al., 1999; Fruehan, 1996).

Producing coke for the steel industry seems to be moving towards the single chamber system (SCS) developed in 1992 by the European Cokemaking Technology Centre in the so-called jumbo coking reactor (Fig. 8). The SCS, apart from saving energy, considerably improves the quality of the coke used in a blast furnace. The coke strength after reaction (CSR) level increases in comparison to coke produced in

coking plants, and it also reduces environmentally damaging emissions (dust,  $SO_2$ ,  $NO_x$ , CO and  $H_2S$ ) up to 50%.

As well as the innovative expectations created by North American new technologies (NRP), the Japanese (Scope 21) and the European ones (SCS), progress can be affected by process control improvement, preheating and hydraulic cleaning of multi-

chamber modern doors that will allow an increase in operating life.

### Secondary Metallurgy

Secondary metallurgy or ladle metallurgy comprises processes and operations aimed at transforming BOS or EAF steel into a calibrated

Fig. 5. Interaction among BOF process and other technologies in the primary steel industry.

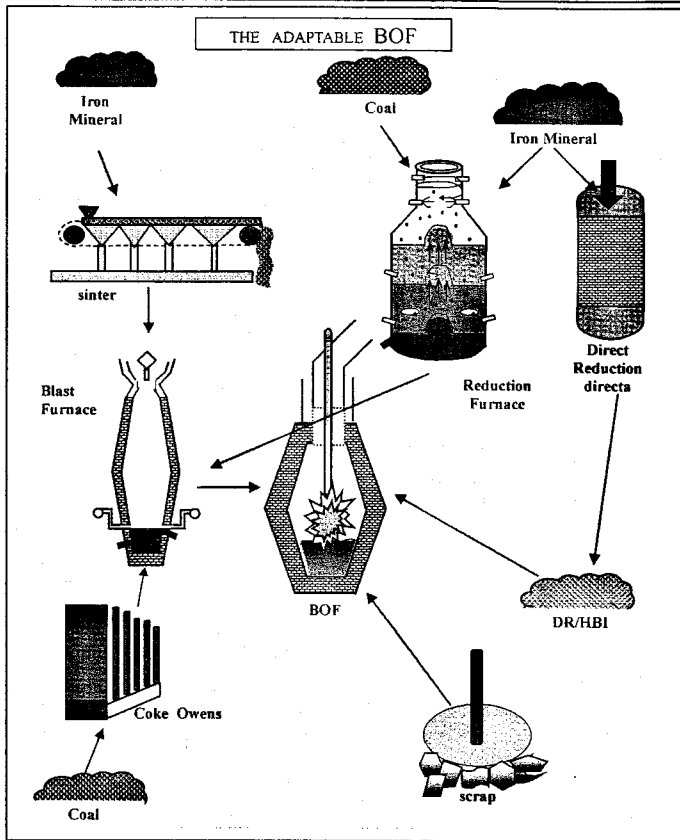

Fig. 7. Direct reduction scheme according to the American Iron and Steel Institute.

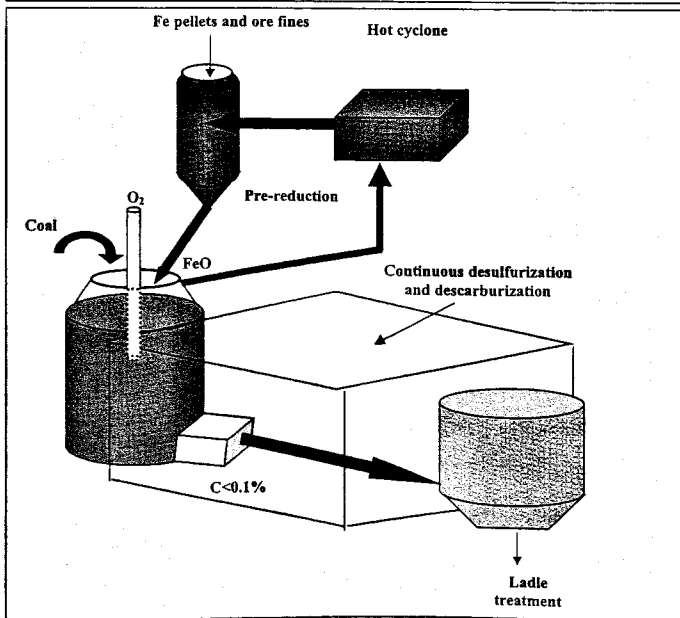

Fig. 6. Interaction among EAF and other technologies in the primary steel industry.

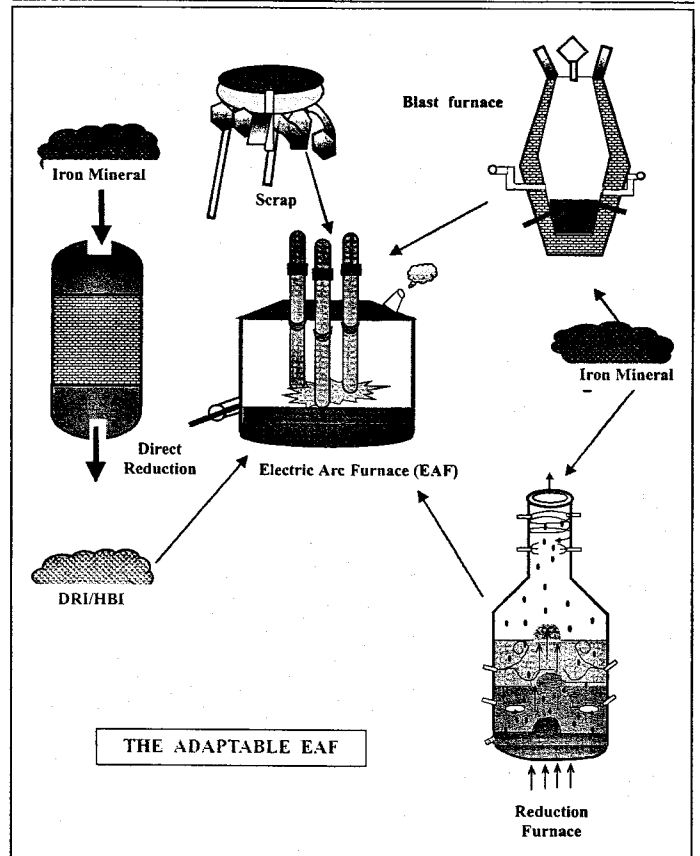

Fig. 8. Single chamber system (SCS) process; jumbo reactor.

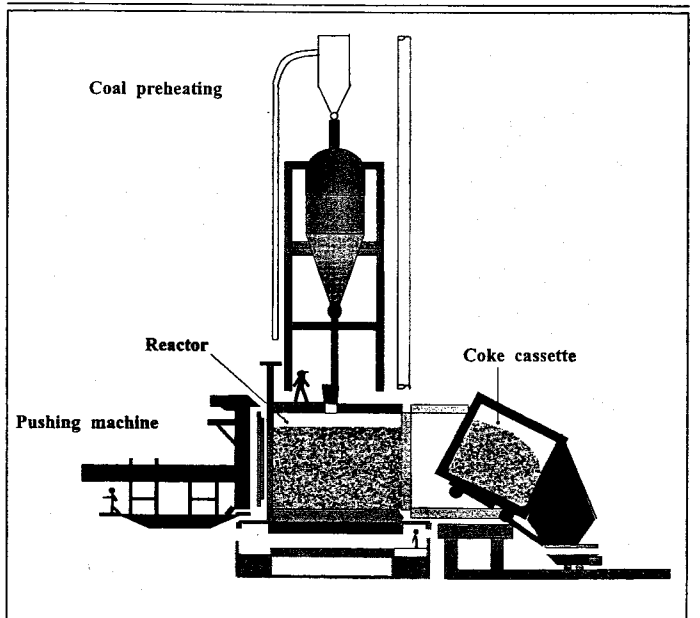

Table 4. Gas emissions in a multichamber coke factory compared with the required standards

Gas	Ambient Air Quality Standard	Maximum Additional Load Outside	
		Wet Quenching Tower	Coke Dry Quenching
CO	10 mg/m <sup>3</sup>	≤0.001 mg/m <sup>3</sup>	≤0.1 mg/m <sup>3</sup>
SO <sub>2</sub>	0.14 mg/m <sup>3</sup>	≤0.0001 mg/m <sup>3</sup>	≤0.001 mg/m <sup>3</sup>
H <sub>2</sub> S		≤0.4 µg/m <sup>3</sup>	≤0.4 µg/m <sup>3</sup>

Table 5. Thin slab casting technology (TSC)

Process	Engineering	Flat Width	Year of Start-up
CSP	Schloemann Siemag AG	50 mm	1989
ISP	Mannesmann Demag	60 mm	1992
FTSR	Danieli	70 mm	1997
CONROLL	Voest — Alpine	75 mm to 125 mm	1998
SMS Concast	SMS Schloemann Siemag	100 mm	1996
TSP	Tippins — Samsung	100 mm	1997
SUMITOMO	Sumitomo Metal Industries	100 mm	1996

metal prepared for solidifying but without any type of thermal, chemical or metal cleaning adjustment (inclusions level).

Since their start in the early 1950s, these technologies have been developing remarkably in terms of better devices, reactivities and tools for reaching the goals of secondary metallurgy (Reisinger et al., 1998). Some examples follow:

- Powder injecting techniques, such as those possible in a ladle treatment station (LTS). By adding synthetic slag, iron alloys and rare metals to the liquid in a LTS, the amounts of oxygen and sulphur and the quantity and shape of the inclusions can be adjusted.
- Vacuum technologies, such as Ruhrstahl-Heraeus (RH) plants or vacuum tank degasser (VD), specially designed for capturing hydrogen, nitrogen or carbon from the liquid.
- Ladle metal heating techniques such as ladle furnace (LF) or chemical heating facility (CHF) specialized in adjusting cast composition, temperature and oxygen potential.
- Processes for adding iron alloys to the refined liquid, e.g., the composition adjustment system (CAS), which provides an opti-

imum metallurgic performance when adjusting alloying and desoxyding elements.

Each technology in secondary metallurgy is specially aimed at improving two or three metallurgic features in the refined metal but none of these work globally on its own for "adjusting" the metal before it solidifies. This multiplication of operations implies two important downsides: time loss and therefore a decrease in the facilities' productivity and, above all, a dangerous temperature fall; and liquid contamination when there is contact with the air (the metal renitrides and reoxides).

That is why secondary metallurgy will have a strong simplifying effect, gathering all the objectives looked for in cast specifications in a single operation. For example, in the new technologies for vacuum refining, a phosphorous and sulphur refining practice is being used, as well as temperature controlling mechanisms. However, discontinuous secondary metallurgy processes will survive or not depending on surplus value and demand for the achieved quality. Using continuous treatment systems could solve problems with adjusting alloying elements in the cast when

regulating the specification marked concentration with the casting process speed.

### Tertiary Metallurgy

Tertiary steel metallurgy equals operations and processes carried out on the calibrated liquid steel when solidifying.

Tertiary steel metallurgy interacts with secondary metallurgy in such a way that it tends to keep and even improve (inclusion contents) the quality of the calibrated melt in ladle metallurgy. On the other hand, tertiary metallurgy, also restrictively called metallurgy in Tundish, overlaps with operations typical of the plastic deformation of hot steel framed within what can be called quaternary metallurgy. For example, casting medium (100 mm) or thin (<100 mm) slabs interferes with the continuous finishing boxes in the traditional hot-strip mill (Table 5; Fig. 9; ITM Consulting, 1997) The capacity to offer a finished product optimizing the investments can be understood with this example: a plant where 2 Mt hot rolled steel sheet coil can be produced in the conventional way (blast furnace) may cost up to US\$620 million, whereas, the same plant would cost US\$400 million if it followed the production sequence EAF → TSC (thin slab casting). Nevertheless, in relation to finished product quality criteria, it should be noted that only 13% of the slab in the market can be made through EAF (100% fed with scrap) coupled to TSC technologies.

Although some problems, not really negligible, have been quoted in the surface finish of TSC-made products, 55% of the slab market meets the quality criteria reached by the TSC hot sheet. The main difficulties to be solved in the future are:

- Chemical heterogeneity appearing in the solidified product due to alloy elements segregating; the thinner the solidified steel strip is, the worse it is (Pero-Sanz, 2000).

Fig. 9. Continuous thin slab casting (TSC) process scheme.

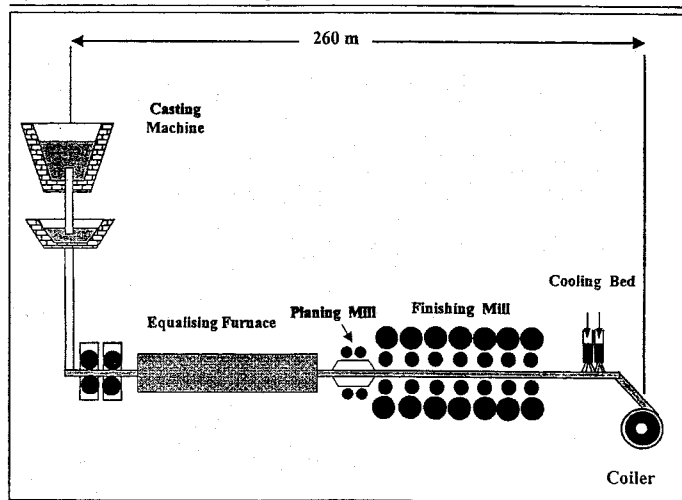
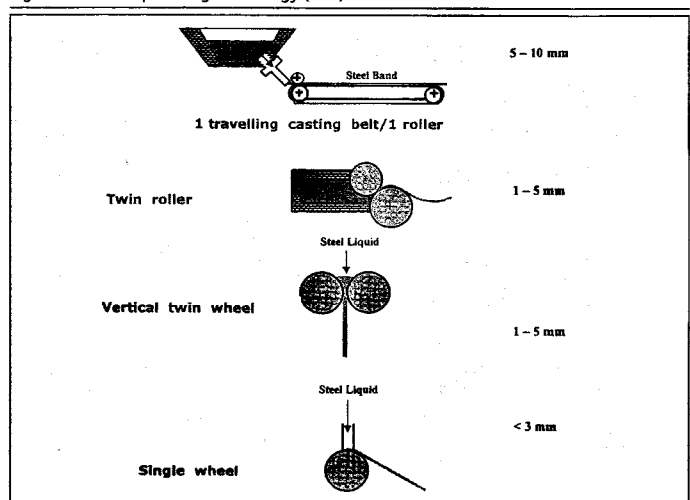

Fig. 10. Direct strip casting technology (DSC).



- Presence of residuals (Cu, Sn, Ni) in the scrap fed into the EAF.

Alternatives are being proposed for properly linking up BOF and TSC technologies in order to solve the problem about residuals.

There is another example of the stronger and stronger interaction between tertiary and quaternary steel metallurgy when casting long bone shaped products (beam blank). In this case, the five times that an equivalent section-bloom should go through the smoothing mill (breakdown) before the material is fed into the universal mill are eliminated from the process. When making determinate sections, productivity increases by 8%; when continuously casting a "beam blank" instead of a bloom, energy consumption decreases 28% (Wolfram et al., 1995).

One of the future challenges for the tertiary steel metallurgy is preparing the direct strip casting (DSC) for a steel coil. Figures 10, 11 and 12 show the profiled technologies for direct slab casting.

Theoretically, the cost of installing a ton of hot cylinder with the EAF + DSC sequence would be four times lower than the BF + BOF + TBC (HRP) alternative and production costs would be half as much. However, these spectacular economic figures should be considered with the corresponding steel quality parameters, which is still far from happening yet. The disadvantages that DSC technologies face when producing high quality carbon steel are:

- Surface problems due to the high liquidus temperature in the Fe-C system and to the speed that metal oxidation kinetics reach at these thermal levels.
- Chemical heterogeneity in the composition; segregations.
- Residual elements; mechanical properties affected.

Therefore, the first pilot trials of DSC technology development are logically being focussed on stainless steel production; since chemical and surface problems (corrosion) are not as important as those of carbon steel (Perosanz, 2000).

Finally, a brief comment will be made about moulding, tertiary metallurgy technology with frequent interactions with quaternary processes. It is an equally outstanding protagonist in the ferrous materials' "quiet revolution" of the last three decades of the last century. In fact, castings (Fe-C alloys; >2.11% C) are an essential raw material for making parts (finished product) through moulding technologies and are anonymously leading to notable improvements in the mechanical properties of these materials while reaching steel-like levels, thanks to chemical composition and thermal treatments. In developed countries, the casting market is 11.5% of the whole steel production, therefore, under the predictions established in Table 2, by the year 2010, the world's casting production would reach 113 Mt.

### Quaternary Metallurgy

Quaternary metallurgy is understood as the processes related to steel's plastic deformation, thermal treatment, coating and protection. Normally, all operations and processes of quaternary steel metallurgy generate ready for market products or semi-transformed materials. The following is a possible classification for finished products from quaternary steel metallurgy: long products, representing 41% of steel production; and flat products, constituting 43% of steel production.

All strip products can be made through the production sequence BF + BOF + HRP (hot

rolling processing) and only 75% of strip can be made using EAF and scrap as the only ferrous component. In these circumstances, there is a strong competition between minimills and blast furnace or BOF-made products. The future orientation, therefore, is that most of the strip (75%) not having any specific quality problems with using scrap or special moulding techniques may be made by co-ordinating the electric furnace with thin slab casting (TSC) or direct strip casting (DSC) technologies. Nevertheless, some qualities cannot be met in strip production by any way other than the traditional one: BF + BOF + HRP. These would be, for example, certain high resistance perlitic qualities used for making high speed rails or tire strengthening (tire steel cord). Perlite, with a traction resistance of up to 3000 MPa, is a composite material made of a metallic mould ferritic matrix reinforced with cementite (Fe<sub>3</sub>C) ceramic material fibres (Fig. 13).

Although an important production of strip could be made in minimills, only 15% of the slab qualities in the market can be produced by an electric furnace fed with 100% scrap. The future alternatives to the blast furnace for making slab are:

- Reducing fusion processes (COREX, AISI; Table 3) linked to TSC technologies and, if required by the quality of the plate surface, finished with a cold milling step.
- EAF process fed with DRI/HBI mixture and scrap (Table 3), coordinated with moulding processes linked to TSC.

As a comparison, production costs of a hypothetical set of facilities able to supply 1 Mt of galvanized plate for the automobile industry are:

- EAF + HRP (hot rolling processing), conventional hot milling + galvanizing: \$570/t (Fig. 14; Knepe and Rosenthal, 1998).

Fig. 11. DSC technology; COILCAST.

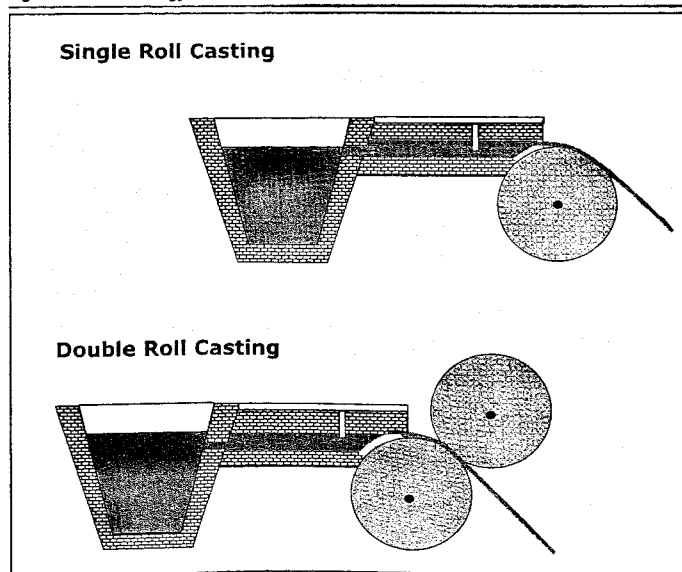

Fig. 12. DSC detail for obtaining hot laminated cylinder.

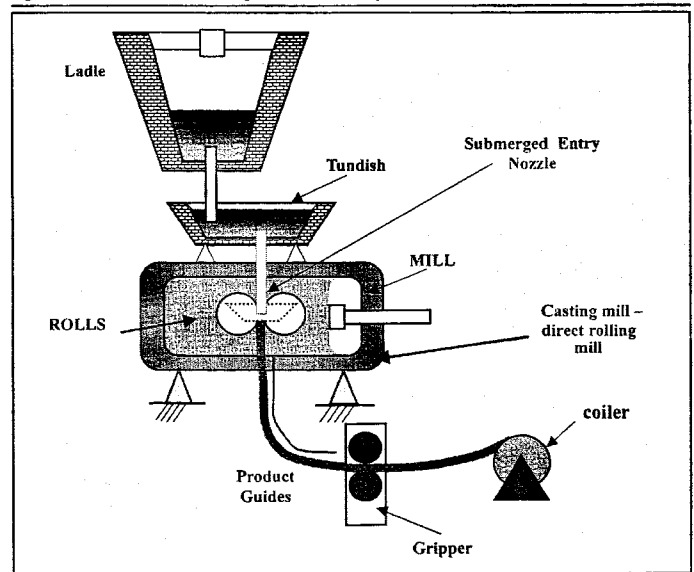
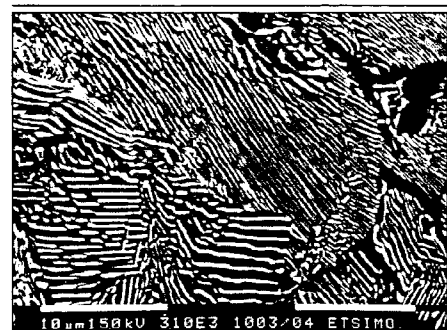

Fig. 13. SEM image of the perlite grains (material made with a metallic mould).



- EAF + HRP, conventional hot milling + cold milling + galvanizing: \$670/t.
- BF + BOF + HRP, conventional hot milling + cold milling + galvanizing: \$690/t.

Using electric steel in the automobile industry would only be competitive in the quantities of hot laminated plate that can be used as such in the vehicle structure (structural and strengthening parts).

In the future, when formulas for linking both BOF and EAF with TSC and DSC casting and moulding technologies develop, production costs for most of the qualities will go down. The concept of compact steel making (minimill) has developed using the electric furnace as the head of the process. Some solutions are being suggested for integrating TSC moulding technologies with the BOF process, as was already foreseen in the tertiary steel metallurgy. This would mean a reduction in steel production costs in the automobile industry.

Finally, some considerations about three qualities of slab with a high added value are: sound deadening sheets; ferrolite; and tinplate.

Sound deadening sheets are made of two steel sheets separated by a thermoplastic polymer. Above the temperature of the polymer's vitreous transition, it behaves like a stiff liquid, adapting to any plastic deformations the steel has to go through.

Ferrolite is a 0.10 mm to 1.40 mm thick steel sheet covered with 15 µm to 200 µm thick colourable polymers. It is marketed for the building and packaging industries.

HRP: Hot rolling processing = conventional hot strip mill. Tinplate consumption represents 2.0% of the world's steel production. It is fighting to find its place in the packaging industry, in hard competition against other metals (aluminium), carton paper, plastic and glass.

The following are the costs of producing tinplate via EAF or BOF:

- EAF + conventional hot milling + CRP, cold milling (0.14 mm) + electrolytic tin plating: \$610/t.
- BF + BOF + HRP, conventional hot milling + CRP, cold milling (0.12 mm double reduction tinplate) + electrolytic tin plating is \$640/t.

Expectations for reducing costs in the future, just as with galvanized plate for automobiles, will come from integrative formulas for traditional plastic deformation technologies and TSC or DSC moulding (Fig. 14).

In the special case of using tinplate for beverage cans, the final thickness reached by the inlaid product is 0.10 mm, although the strong competition with aluminum is now forcing the development of a new generation of 0.06 mm beverage cans.

Conclusions

Iron, steel and cast-based materials will keep leading the materials science technology in the new millennium not only due to their low costs but also due to their surprising properties and recycling possibilities.

Introducing new technologies in the steel sector will be a fact when they can bring about an actual reduction in the costs and an improvement in the quality of the finished product. Theo-

retically, there are many ways of obtaining pig iron, DRI or calibrated liquid steel. However, for making non-adjusted liquid steel you can at present count on blast furnace (BF), electric furnace (EAF), HYL-III process, Midrex process and BOF converter only. A blast furnace is a particularly illustrative example; developed countries tend to maintain operative furnaces with an annual production over 2.0 Mt only, whereas, in other countries such as Brazil, India or China, some mini blast furnaces with 70 000 to 200 000 tons per year are still profitable. The reason is that such a mature and reliable technology as the blast furnace, with a remarkable ability for assimilating control and automating processes, cannot easily be taken over by other production techniques with costs and operative results which are still uncertain (Fig. 15; Faure, 1993).

Similarly, and in theory, some other materials could be used for making the structure of the 36 million cars globally produced each year. 18 Mt steel could be replaced by aluminium alloys or thermoplastic polymeric materials strengthened with carbon fibres. However, in vehicles they would never reach the price, performance qualities or security that the steel structure has now (Lévy, 1999).

Such a "social" material as steel (75% of strip's and 50% slab's qualities can be produced in any region of the world) would force the creation of new production facilities and a consequent increase in consumption in the original country or region. On the other hand, taking into account the last financial crisis in Asian countries (August 1998), establishing steel industries in emergent nations due to their low labour and raw materials costs is not tempting when the whole production is sold overseas. Therefore, the steel sector would be much more stable if the demand for steel in the developing areas themselves (Hispano-American nations, Asia and Africa, Table 2) were to grow in situ rather than by conquering new markets in foreign countries.

Fig. 14. General features of the traditional hot laminating technology and its integration in TSC moulding processes.

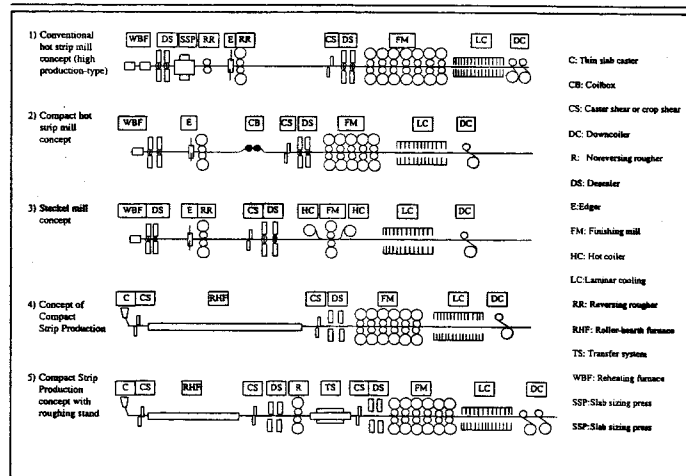
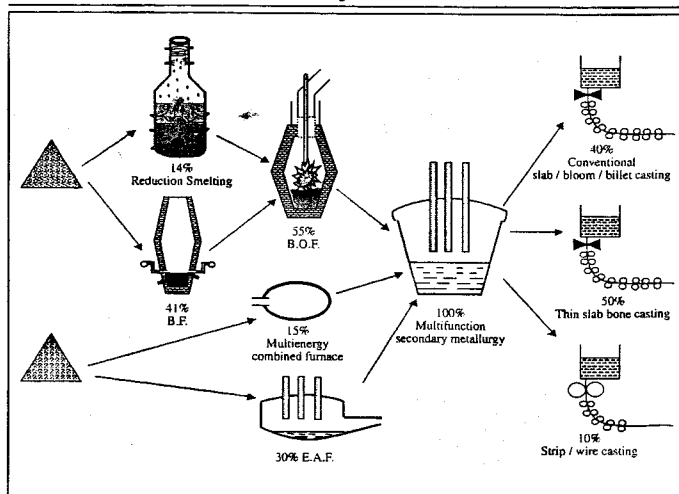

Fig. 15. Different alternatives in steelmaking routes in 2020.



Finally, materials to be used in the third millennium should be produced, transformed and reprocessed with technologies 100% compatible with high recycling and low environmental impact. As a matter of fact, in 1974, steel production energy cost was 33.8 GJ/Mg while today's energy cost is below 18 GJ/Mg. Not all other technological sectors have followed this tendency. If they had, Tokyo's 1998 meeting and its recommendations for stopping climate change by reducing carbon dioxide levels in the atmosphere would have made no sense.

**References**

AGARWAL, J.C., 1991. Strategic considerations in direct steelmaking. *Iron Steelmaking*, 18, p. 69-72.  
 AMELING, D., BAER, H., BERTLING, H. and LÜNGEN, H.B., 1999. Cokemaking technology 2000: State of the art and new structures. *Cokemaking International*, 1, p. 32-39.

EAGER, T., 1998. The quiet revolution in materials manufacturing and production. *Journal of Metals*, 50, p. 19-21.  
 EDINGTON, J., 1997. The new world of steel. *Iron-making Steelmaking*, 24, p. 19-28.  
 FAURE, H.A., 1993. Development, state of the art and future aspects of steelmaking. *La Revue de Métallurgie — CIT*, 90, p. 1439-1449.  
 FRUEHAN, R.J., 1996. Future of steelmaking technologies and role of basic research. *Iron Steelmaking*, 23, p. 25-33.  
 ITM CONSULTING-GENEVA (SWITZERLAND), 1997. Emerging and developing iron and steel making processes for the future. *Batelle Steel Program. Innovation and Technology Management S.A.*, May, p. 133-152.  
 KNEPPE, G. and ROSENTHAL, D., 1998. Hot strip technology: Tasks for the new century. *Metallurgical Plant and Technology International*, 3, p. 56-57.  
 LÉVY, J., 1999. Introduction à la Métallurgie Générale. Editions Les Presses, École de Mines de Paris, Francia, p. 7-10.  
 PERO-SANZ, J.A., 2000. Ciencia e Ingeniería de Materiales: Estructura, Transformaciones, Propiedades y Selección. Editorial Dossat 2000, 4th edition, p. 189-223.

REISINGER, P., FLÖSSHOLZER, H. and SCHRADE, CH., 1998. Current status of secondary steelmaking applications. *Steel World*, 3, p. 39-44.  
 SANCHO, J.P., VERDEJA, L.F. and BALLESTER A., 2000. *Metalurgia Extractiva: Procesos de obtención*. Editorial Sintesis, Madrid, p. 15-161.  
 VERDEJA, L.F., ASENSIO, J. and HUERTA, M<sup>a</sup>.A., 1993. La situación de la industria siderúrgica y análisis de las futuras transformaciones tecnológicas. *Revista de Minas*, 8, p. 131-140.  
 VERDEJA, J.I., SANCHO, J.P. and VERDEJA, L.F., 1998. Materiales tradicionales y nuevos materiales. *Proceedings, Resúmenes del X Congreso Internacional de Minería y Metalurgia*. Asociación Nacional de Ingenieros de Minas de España, 3, p. 557-585.  
 VERDEJA, L.F., SANCHO, J.P. and VERDEJA, J.I., 2000. El proceso siderúrgico: estado actual y perspectivas de futuro. *Revista de Metalurgia*, 19-20, p. 173-181.  
 WIESINGER, H., 1999. To invent the future for the steel industry. *Advanced Steel 1998-99*. Crambeth Allen Publishing, Hong Kong, p. 13-20.  
 WOLFRAM, J., HARTMANN, G., MOSER, H. and MAYRHOFER, K.F., 1999. Minimill handles direct charging of beam blanks. *Advanced Steel 1998-99*. Crambeth Allen Publishing, Hong Kong, p. 90-94.



**THE GEOLOGY, GEOCHEMISTRY, MINERALOGY AND MINERAL BENEFICIATION OF PLATINUM-GROUP ELEMENTS**  
**SPECIAL VOLUME 54**

Edited by L.J. Cabri

This volume is a sequel to CIM Special Volume 23 (Platinum-Group Elements: Mineralogy, Geology, Recovery), published in 1981. Special Volume 54 will provide new information and insights on platinum-group element deposits worldwide in terms of their geological setting, ore controls, mineralogy, geochemistry, mineral processing and beneficiation. Purchasers of the hard-copy volume will also be able to obtain the volume on a CD-ROM. Hard bound; 852 pages, including colour plates.

**ORDER FORM**

Mail to CIM: 1210 – 3400 de Maisonneuve Blvd. W.  
 Montréal, Québec, Canada, H3Z 3B8  
 Fax: (514) 939-2714

CIM Member No. \_\_\_\_\_

Please send me \_\_\_\_\_ copies of Special Volume 54; please include copies of the CD-ROM: yes  no  (check one)

Name \_\_\_\_\_

Address \_\_\_\_\_

Members CDN\$140.00 US\$100.00

Non-Members: CDN\$220.00 US\$150.00

Postal Code \_\_\_\_\_

Students CDN\$100.00 US\$70.00

Orders must be prepaid. Make cheque payable to: Canadian Institute of Mining, Metallurgy and Petroleum.

Canadian residents add 7% G.S.T. on total amount.

Postage and Handling: Canada CDN\$10.00 (US\$7.00); U.S.A. CDN\$15.00 (US\$10.50); Other Countries CDN\$25.00 (US\$17.50). For each volume ordered, a copy of the volume on a CD-ROM may also be ordered for an additional cost of CDN\$25.00 or US\$18.00

Method of Payment: Cheque  Visa  AMEX  MasterCard

Card Number \_\_\_\_\_

Expiry Date: \_\_\_\_\_